

FAMILIA 11D FAMILY

V. BOLA "BASIC" BIDIRECCIONAL BIDIRECTIONAL "BASIC" BALL VALVE

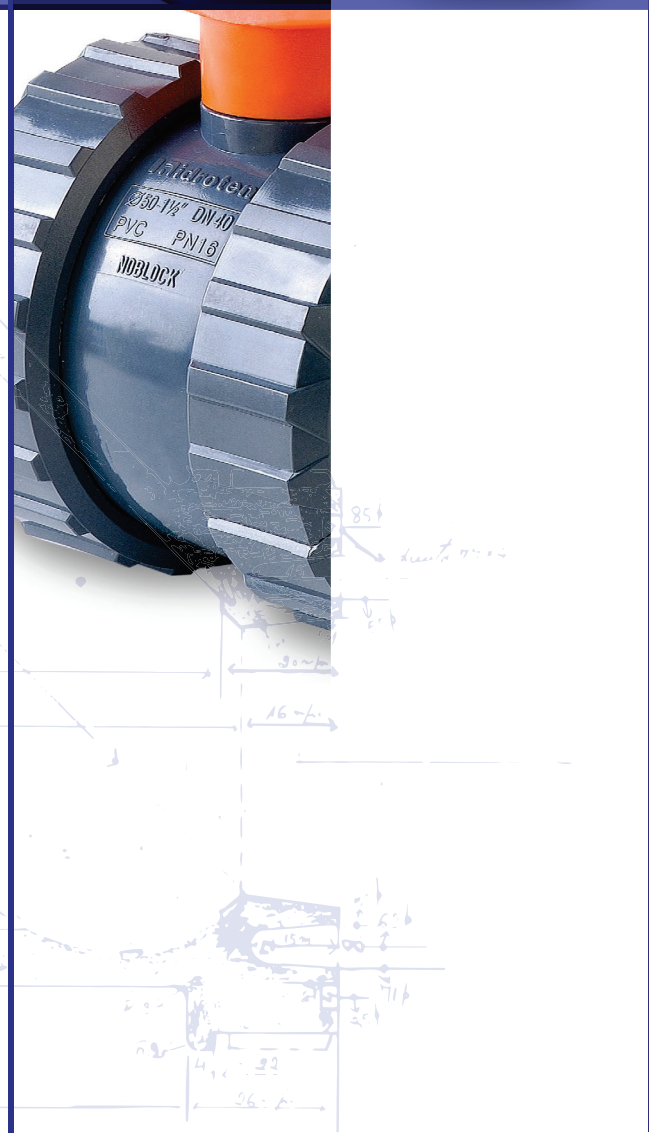

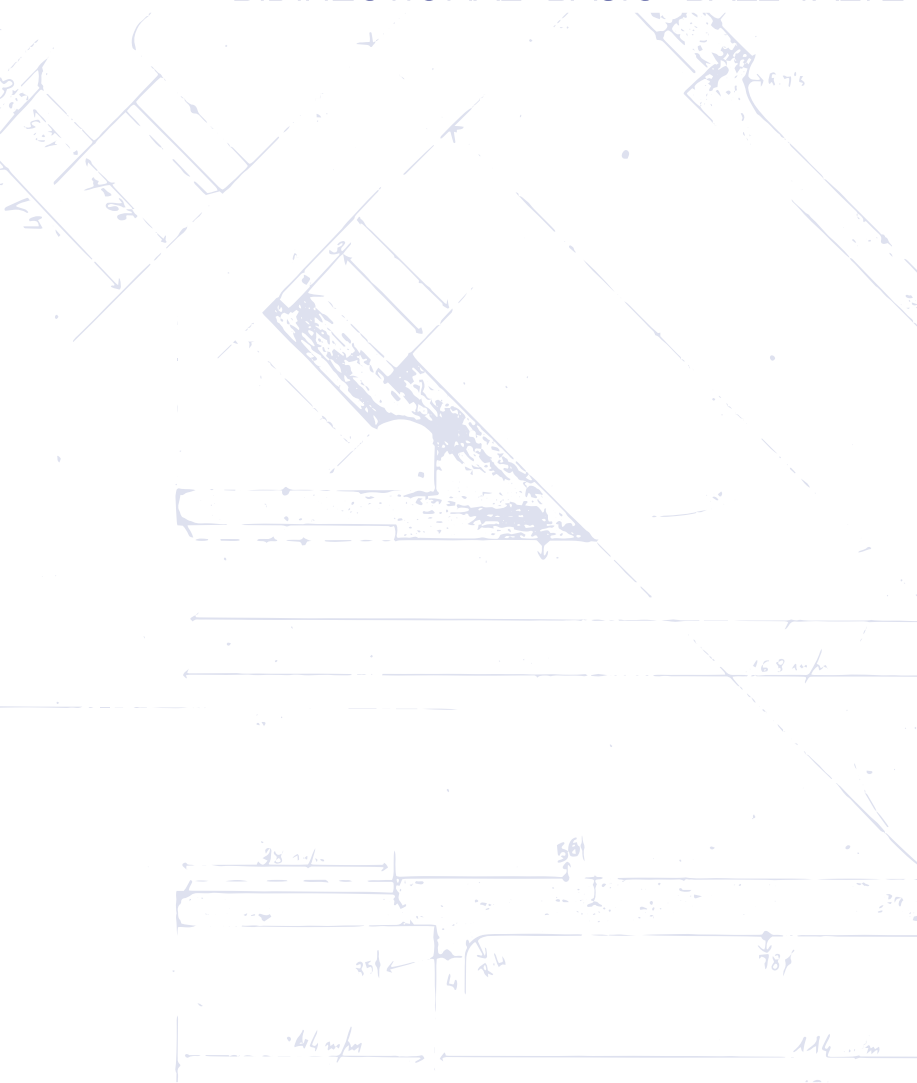

Válvula bidireccional

La gama de válvulas de bola bidireccionales se distinguen por su portateflón roscado, que permite su instalación en cualquier dirección y además proporciona un par de maniobra uniforme. Esto la convierte en una válvula perfecta para aplicaciones industriales al evitar descargas accidentales por instalación incorrecta.

The range of bidirectional ball valves are distinguishable by their threaded teflon adaptor which allows its installation in any direction and provides a uniform operation torque. It turns into the perfect valve for industrial applications as it avoids accidental discharges due to a wrong installation.

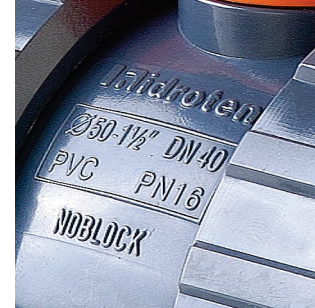

Maneta de doble uso

La maneta de las válvulas bidireccionales no sólo sirven para abrir y cerrar la válvula, sino que se puede utilizar a modo de llave para el ajuste del apriete del portateflón, pudiendo ajustar de este modo el par de maniobra de la misma.

The handle of bidirectional valves is not only used to close or open the valve, but they are also used as a wrench to adjust the teflon adaptor and thus it can adjust the torque.



Perfecta para la motorización

El portateflón roscado ofrece una gran ventaja a la hora de automatizar las instalaciones, ya que se independiza el par de maniobra de la válvula del apriete de las tuercas, teniendo un funcionamiento totalmente estable y alargando la vida de los actuadores que no sufrirán por el aumento de par de la válvula.

The threaded teflon adaptor offers a great advantage when automating installations because the torque of the valve separates from the nut torque and it works in a stable way extending the lifespan of the actuators which will not be affected by the increase of the valve torque.

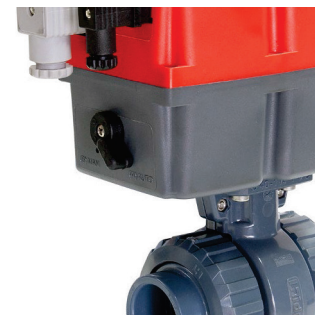

CERTIFICACIONES / CERTIFICATIONS



En tuberías según norma UNE-EN 1452 (PVC-U) y UNE-EN 12201 (PE).

Inside the pipes according to the standard UNE-EN 1452 (PVC-U) and UNE-EN 12201 (PE).



SECTOR	Industria, piscina y agricultura / <i>Industry, swimming pool and agriculture</i>
MATERIAL	PVC-U / <i>PVC-U</i>
CIERRE BOLA / BALL CLOSING	PTFE
JUNTAS TÓRICAS / O-RING	EPDM opción VITON (identificado mediante maneta negra) / <i>EPDM option VITON (identified with black handle)</i>
MANETA / HANDLE	Maneta ergonómica, sobredimensionada y con función de llave de apriete del portateflón / <i>Ergonomic and oversized handle with seal carrier tighten function</i>
MOTORIZACIÓN / ACTUATION	Motorización mediante abrazadera en válvulas "BASIC" desde Ø20 hasta Ø50 y mediante torreta para Ø63, 75 y 90 / <i>Actuation by clamp in "BASIC" from 20 to 50 and by actuator support in 63, 75 and 90.</i>
PN	PN 16 desde Ø20 a 63 / <i>PN 16 from Ø20 to 63</i> PN 10 desde Ø75 a 90 / <i>PN 10 from Ø75 to 90</i>
MEDIDAS / MEASURES	Desde Ø20 a 90, 1/2" - 3" / <i>From Ø20 to 90, 1/2"-3"</i>

DESPIECE / QUARTERING

1. Maneta bidireccional PPFV
2. Junta manguito EPDM
3. Cierre de bola PTFE
4. Junta tórica EPDM
5. Vástago PVC-U
6. Bola PVC-U
7. Junta cierre EPDM
8. Portateflón roscado PVC-U
9. Tuerca V/E PVC-U
10. Manguito salida encolar PVC-U

1. GFPP bidirectional handle
2. EPDM o-ring
3. PTFE ball seal
4. EPDM o-ring
5. PVC-U shaft
6. PVC-U ball
7. EPDM closing seal
8. PVC-U ball seal holder
9. PVC-U nut
10. PVC-U solvent socket outlet

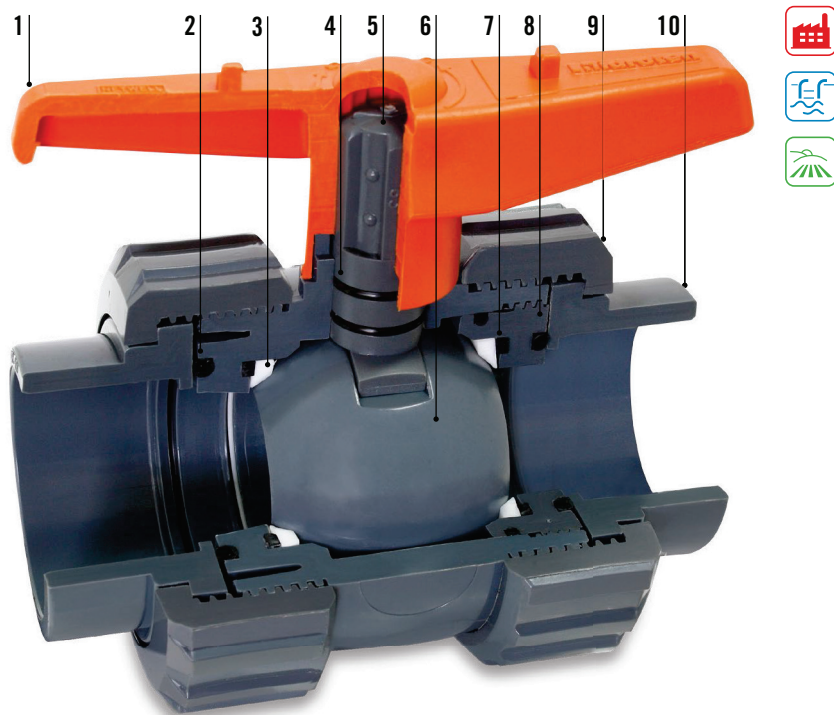

CURVAS PÉRDIDAS DE CARGA / LOAD LOSS CURVES

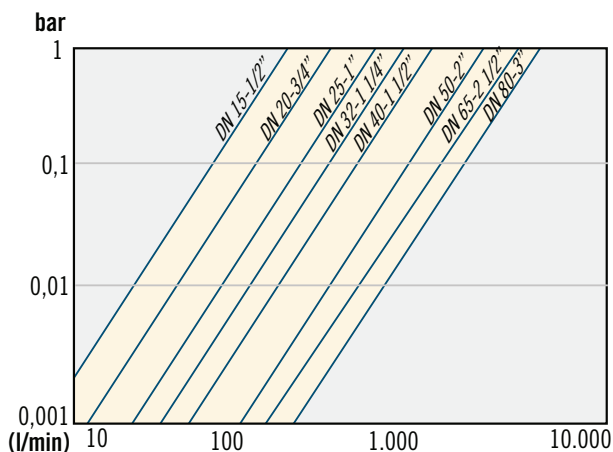

PARES DE MANIOBRA / OPERATION TORQUE

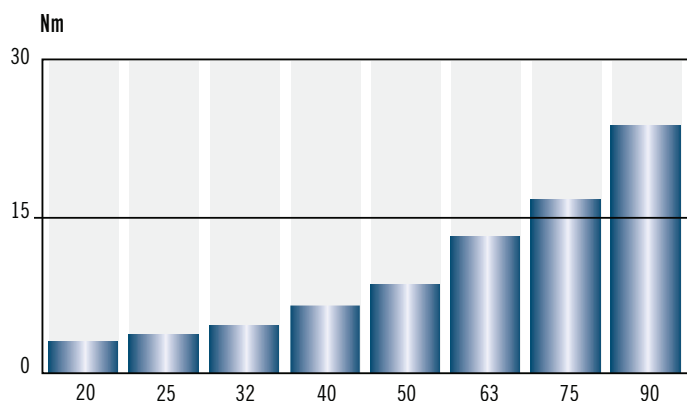

CARACTERÍSTICAS ACTUADOR ELÉCTRICO / ELECTRIC ACTUATORS CHARACTERISTICS

Especificaciones / Specifications	L10	H10	L20	H20	L35	H35	L55	H55
Voltaje (V) / Voltage (V)	12-24 VAC/VDC	85-240 VAC/VDC	12-24 VAC/VDC	85-240 VAC/VDC	12-24 VAC/VDC	85-240 VAC/VDC	12-24 VAC/VDC	85-240 VAC/VDC
Frecuencia (Hz) / Frequency (Hz)	50/60	50/60	50/60	50/60	50/60	50/60	50/60	50/60
Tiempo maniobra en vacío (s) / operation time unload (s)	17	17	10	10	10	10	13	14
Par maniobra (Nm) / Maneuver coupling (Nm)	10	10	25	25	35	35	55	55
Par arranque (Nm) / Starting coupling (Nm)	12	12	25	25	38	38	60	60
Tiempo bajo tensión (%) / Time under pressure (%)	75	75	75	75	75	75	75	75
Protección IEC 60529 / Protection IEC 60529	IP-65	IP-65	IP-67	IP-67	IP-67	IP-67	IP-67	IP-67
Ángulo maniobra (°) / Maneuver angle (°)	90° - 270°							
Temperatura (°C) / Temperature (°C)	-20°C +70°C							
Interruptor final carrera / Switch box assy	4 SPDT micro							
Resistencia calefactora (W) / Heater resistance (W)	3,5							
Conectores / Connectors	DIN 43650 ISO 440 & C192							
Conexión ISO 5211 / Connection ISO 5211	F-03 F-05		F-03 F-04 F-05		F-03 F-04 F-05		F-05 F-07	F-05 F-07
Conexión DIN 3337 - Doble cuadrado Estándar/Opcional Connection DIN 3337 - Standard double frame/optional	14 / 9 ó 11		14 / 9 ó 11		14 / 9 ó 11		17 / 14	17 / 14
Peso (kg) / Weight (kg)	0,9	0,9	1,8	1,8	1,9	1,9	2,4	2,4

- Actuadores eléctricos multivoltaje rotativos de 1/4" de vuelta.
- Control electrónico del par para obtener un funcionamiento suave y suspendiendo la alimentación en caso de ser sobrepasado el par máximo (obstrucciones), protegiendo el mecanismo del actuador.
- Control visual de operación mediante un led externo indicador del estado del actuador.
- Mando manual de emergencia, seleccionando el funcionamiento manual, se aísla el motor de los engranajes y se puede accionar manualmente la válvula.
- Control automático de la temperatura, gracias a un calefactor interno para mantener la temperatura interior entre 20 y 30°C y evitar así daños por condensación.
- Materiales anticorrosivos para un funcionamiento óptimo en cualquier ambiente.
- Opción de posicionador digital DPS 2005 para señales de control 4-20 mA 0-10V.
- Opción cierre de seguridad mediante baterías, sistema BSR.

- Electric multi-voltage actuator, rotation of 1/4" revolution.
- Electronic control of the coupling in order to ensure a smooth functioning and to suspend alimentation if it exceeds the maximal coupling (obstructions), which protects the actuator mechanism.
- Visual control of the operation by means of an external LED showing the actuator state.
- Emergency manual command, by selecting the manual use, the engine gets isolated from the gear assembly and it is possible to act the valve manually.
- Automatic temperature control, by means of an inner heater to maintain the internal temperature between 20 and 30°C, avoiding damages that could be caused by condensation.
- Anticorrosive materials for an optimal functional in any environment.
- Option of digital positioner DPS 2005 for control signals 4-20mA 0-10V.
- Option of security closing using batteries, BSR system.

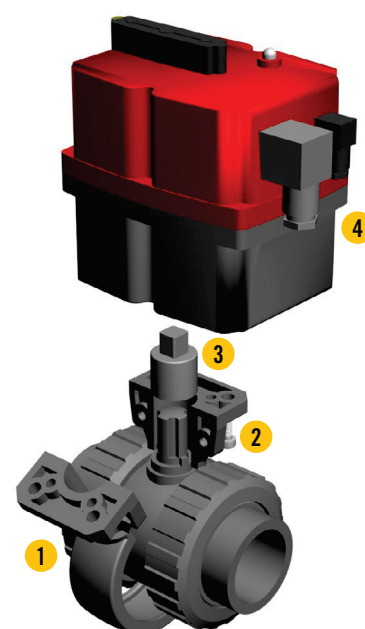

Motorización sistema Bidireccional.
Actuation Bidirectional System.

N.	SECUENCIA / SEQUENCE
1	Válv. bidireccional / Bidirectional valve
2	Abrazadera soporte / Clamp support
3	Adaptador / Adapter
4	Actuador / Actuator

■ CARACTERÍSTICAS ACTUADOR NEUMÁTICO / PNEUMATIC ACTUATORS CHARACTERISTICS

- Los actuadores de Simple efecto, son aquellos que realizan la apertura mediante aire y el cierre mediante unos muelles de seguridad.
- Single acting ensures the opening by means of air and the closing by means of security springs.

MODELO MODEL	CONSUMO CONSUMPTION (Lt/ciclo)	PAR MUELLES (Nm) SPRING TORQUE		PAR ALIMENTADOR (Nm) FEEDER TORQUE		PESO (Kg.) WEIGHT	Presión aire 6 bar tiempo maniobra (sec.) / Air pressure 6 bar maneuver time	
		0°	90°	0°	90°		APERTURA OPENING	CIERRE CLOSING
H050 SE	0,23	11,5	7,0	11,5	7,0	1,2	0,6	0,6
H063 SE	0,45	18,5	12,5	18,5	12,5	1,8	0,7	0,9
H075 SE	0,61	45,1	25,3	45,2	25,3	3,3	0,6	1
H100 SE	1,8	106,4	60,0	106,4	60,0	6,8	1,1	1,3

- Los actuadores de Doble efecto, son aquellos que tanto para el movimiento de apertura como para el de cierre lo realizan mediante aire.
- Double acting ensures both opening and closing movement using air.

MODELO MODEL	CONSUMO CONSUMPTION (Lt/ciclo)	PAR ACTUADOR MODEL	PESO ACTUADOR (Kg.) ACTUATOR WEIGHT	Presión aire 6 bar tiempo maniobra (sec.) / Air pressure 6 bar maneuver time	
				APERTURA OPENING	CIERRE CLOSING
H050 DE	0,23	18,5 Nm	1,07	0,6	0,6
H075 DE	0,61	70,2 Nm	2,90	0,6	0,7

- Acabado de la superficie inferior del cuerpo (Ra 0,4-0.6 um) para reducir al mín. la fricción y maximizar la vida del actuador. Protección externa cuerpo: anodizado duro. 500 Hrs. Cámara Niebla salina según ASTM B117-73. Protección externa tapas: recubrimiento epoxy-poliéster.
- Patines deslizantes, material de bajo cociente de fricción (LAT LUB) evitando contacto metal-metal, fácilmente reemplazable, para su mantenimiento con doble taladro inferior para el anclaje y centraje de la válvula según norma ISO 5211 y DIN 3337.
- Conexión inferior eje cuadrado hembra según ISO 5211/DIN 3337 para el montaje a 45° o 90° indistintamente.
- Montaje directo electroválvula NORMA NAMUR. / Montaje accesorios según norma NAMUR VDI/DE 3845.
- Temperatura de trabajo -20°C a +80°C.
- Limitador de carrera a la apertura y al cierre; control de funcionamiento y estanqueidad 100% a través del sistema electrónico. Certificación individual.

- Finish of the body lower surface (Ra 0.4-0.6 um) to reduce at min. the friction and maximize the actuator life. Body external protection: strong anodized 500Hrs. Salt fog chamber according to ASTM B117 -73. Lid external protection: epoxy-polyester coating.
- Slipping skates, low friction quotient material (LAT LUB) avoiding metal-metal contact, easily replaceable, for its maintenance with lower double hole for anchoring and centering of the valve according to ISO 5211 and DIN 3337 standards.
- Lower connection with female square shape axis according to ISO 5211/DIN 3337 for 45° or 90° assembly, without distinction.
- Direct assembly of electrovalve NAMUR STANDARD / Fitting assembly according to NAMUR VDI/DE 3845.
- Working temperature from -20°C to +80°C.
- Motion limiter for opening and closing; Control of functioning and impermeability 100% through the electronic system. Individual certification.

■ AJUSTE PORTATEFLÓN / ADJUSTMENT PORT-TEFLON

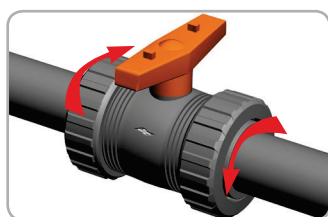

1. Liberar el cuerpo de la válvula, aflojando las tuercas en el sentido de las flechas. / Release the valve body untightening the nuts as shown in the picture.

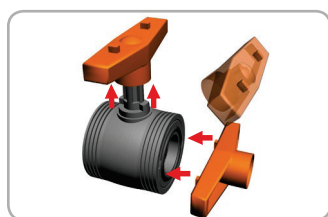

2. Manteniendo la válvula en posición cerrada sacamos la maneta, que acoplamos al portateflón, sirviendo de herramienta. / With closed valve, release the handle, and use it as wrench in the closing carrier.



3. Una vez ajustado el portateflón volvemos a colocar la maneta. / Once the closing carrier is adjusted, the handle is placed again.

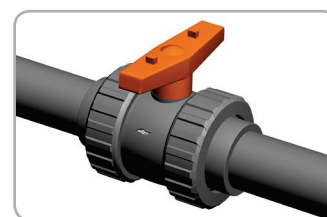

4. Volvemos a colocar la válvula apretando las tuercas, y el sistema puede trabajar con normalidad. / Fit the valve again, tightening the nuts and keep working normally.

VÁLVULA DE BOLA "BASIC" BIDIRECCIONAL / BIDIRECTIONAL "BASIC" BALL VALVE

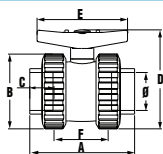

643/648

PTFE

VITON

Salida encolar
Solvent socket outlet
Sortie à collier

CÓDIGO / CODE	CÓDIGO / CODE	Ø TUBO / PIPE	DN	PESO / WT (g.)	A	B	C	D	E	F
11D150	11D474	20	15	148	86	55	16	74	80	44
11D151	11D475	25	20	186	94	62	19	80	80	49
11D152	11D476	32	25	312	122	72	23	103	101	66
11D153	11D477	40	32	538	131	88	25	125	130	71
11D154	11D478	50	40	782	150	103	31	138	130	75
11D155	11D479	63	50	1.218	177	120	38	177	170	89
11D156	11D480	75	65	2.650	216	150	45	215	260	119
11D157	11D481	90	80	4.230	257	181	51	252	260	140



SISTEMA
NOTUB

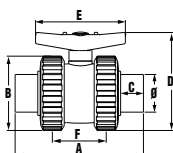

785/788

PTFE

VITON

Salida encolar macho
Male solvent socket outlet
Sortie male à collier

CÓDIGO / CODE	CÓDIGO / CODE	Ø TUBO / PIPE	DN	PESO / WT (g.)	A	B	C	D	E	F
11D120	11D250	20	15	158	104	55	16	74	80	44
11D121	11D251	25	20	200	112	62	19	80	80	49
11D122	11D252	32	25	332	142	72	23	103	101	66
11D123	11D253	40	32	574	165	88	25	125	130	71
11D124	11D254	50	40	838	180	103	31	138	130	75
11D125	11D255	63	50	1.308	210	120	38	177	170	89



SISTEMA
NOTUB

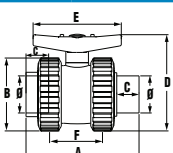

786/789

PTFE

VITON

Salida encolar macho/encolar hembra
Male solvent socket/female solvent socket outlet
Sortie male-femelle à collier

CÓDIGO / CODE	CÓDIGO / CODE	Ø TUBO / PIPE	DN	PESO / WT (g.)	A	B	C	D	E	F
11D110	11D260	20	15	153	95	55	16	74	80	44
11D111	11D261	25	20	193	103	62	19	80	80	49
11D112	11D262	32	25	322	132	72	23	103	101	66
11D113	11D263	40	32	556	143	88	25	125	130	71
11D114	11D264	50	40	810	165	103	31	138	130	75
11D115	11D265	63	50	1.263	194	120	38	177	170	89



SISTEMA
NOTUB

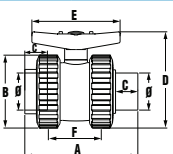

787/790

PTFE

VITON

Salida mixta encolar macho R/H
Male solvent socket/female threaded outlet
Sortie mix male à collier/tarudée

CÓDIGO / CODE	CÓDIGO / CODE	Ø - r	DN	PESO / WT (g.)	A	B	C	D	E	F	G
11D100	11D270	20-1/2"	15	155	95	55	16	74	80	44	17
11D101	11D271	25-3/4"	20	197	108	62	19	80	80	49	20
11D102	11D272	32-1"	25	324	132	72	23	103	101	66	23
11D103	11D273	40-1 1/4"	32	557	143	88	25	125	130	71	26
11D104	11D274	50-1 1/2"	40	830	170	103	31	138	130	75	33
11D105	11D275	63-2"	50	1.365	197	120	38	177	170	89	29

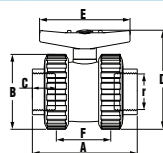

646/651

PTFE

VITON

Salida R/Hembra
Female-female threaded outlet
Sortie taraudée

CÓDIGO / CODE	CÓDIGO / CODE	r	DN	PESO / WT (g.)	A	B	C	D	E	F
11D140	11D492	1/2"	15	154	86	55	17	74	80	44
11D141	11D493	3/4"	20	194	99	62	20	80	80	49
11D142	11D494	1"	25	315	122	72	23	103	101	66
11D143	11D495	1 1/4"	32	540	131	88	26	125	130	71
11D144	11D496	1 1/2"	40	816	155	103	33	138	130	75
11D145	11D497	2"	50	1.304	180	120	29	177	170	89
11D146	11D498	2 1/2"	65	2.710	202	150	33	215	260	119
11D147	11D499	3"	80	4.360	232	181	36	252	260	140

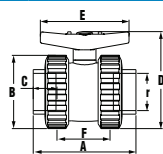

647/652

PTFE

VITON

Salida R/H reforzada
Reinforced female threaded outlet
Sortie taraudée renforcée

CÓDIGO / CODE	CÓDIGO / CODE	r	DN	PESO / WT (g.)	A	B	C	D	E	F
11D200	11D220	1/2"	15	174	86	55	17	74	80	44
11D201	11D221	3/4"	20	218	99	62	20	80	80	49
11D202	11D222	1"	25	343	122	72	23	103	101	66
11D203	11D223	1 1/4"	32	576	131	88	26	125	130	71
11D204	11D224	1 1/2"	40	866	155	103	33	138	130	75
11D205	11D225	2"	50	1.374	180	120	29	177	170	89
11D206	11D226	2 1/2"	65	2.780	202	150	33	215	260	119
11D207	11D227	3"	80	4.480	232	181	36	252	260	140

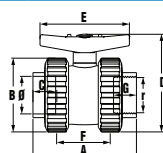

644/649

PTFE

VITON

Salida mixta encolar R/H
Solvent socket/female threaded outlet
Sortie mixte

CÓDIGO / CODE	CÓDIGO / CODE	Ø - r	DN	PESO / WT (g.)	A	B	C	D	E	F	G
11D160	11D483	20-1/2"	15	150	86	55	16	74	80	44	17
11D161	11D484	25-3/4"	20	190	99	62	19	80	80	49	20
11D162	11D485	32-1"	25	314	122	72	23	103	101	66	23
11D163	11D486	40-1 1/4"	32	539	131	88	25	125	130	71	26
11D164	11D487	50-1 1/2"	40	802	155	103	31	138	130	75	33
11D165	11D488	63-2"	50	1.320	180	120	38	177	170	89	29
11D166	11D489	75-2 1/2"	65	2.680	202	150	45	215	260	119	33
11D167	11D490	90-3"	80	4.290	245	181	51	252	260	140	36

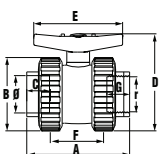

645/650

PTFE

VITON

Salida mixta encolar R/H reforz.
Reinforced solvent socket/female threaded outlet
Sortie mixte renforcée

CÓDIGO / CODE	CÓDIGO / CODE	Ø - r	DN	PESO / WT (g.)	A	B	C	D	E	F	G
11D210	11D230	20-1/2"	15	160	86	55	16	74	80	44	17
11D211	11D231	25-3/4"	20	202	99	62	19	80	80	49	20
11D212	11D232	32-1"	25	328	122	72	23	103	101	66	23
11D213	11D233	40-1 1/4"	32	557	131	88	25	125	130	71	26
11D214	11D234	50-1 1/2"	40	827	155	103	31	138	130	75	33
11D215	11D235	63-2"	50	1.355	180	120	38	177	170	89	29
11D216	11D236	75-2 1/2"	65	2.725	202	150	45	215	260	119	33
11D217	11D237	90-3"	80	4.350	245	181	51	252	260	140	36

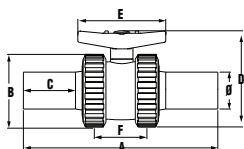

Salida termofusión
Thermofusion outlet
Sortie thermofusion

686/687



CÓDIGO / CODE	CÓDIGO / CODE	Ø TUBO / PIPE	DN	PESO / WT (g.)	A	B	C	D	E	F
11D130	11D240	20	15	155	212	55	65	74	80	44
11D131	11D241	25	20	194	221	62	65	80	80	49
11D132	11D242	32	25	312	256	72	70	103	101	66
11D133	11D243	40	32	538	261	88	70	125	130	71
11D134	11D244	50	40	782	285	103	79	138	130	75
11D135	11D245	63	50	1.218	327	120	89	177	170	89
11D136	11D246	75	65	2.650	369	150	91	215	260	119
11D137	11D247	90	80	4.230	410	181	100	252	260	140

COMBINACIÓN DE GAMA / COMBINATION RANGE

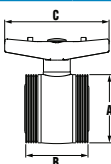

Cuerpo central
Main body
Corps central

608/609



CÓDIGO / CODE	CÓDIGO / CODE	Ø TUBO / PIPE	DN	PESO / WT (g.)	A	B	C
11D750	11D760	20	15	83	42	44	73
11D751	11D761	25	20	101	47	49	73
11D752	11D762	32	25	199	57	66	110
11D753	11D763	40	32	324	71	71	120
11D754	11D764	50	40	422	83	75	120
11D755	11D765	63	50	700	98	89	178
11D756	11D766	75	65	1.495	127	119	260
11D757	11D767	90	80	2.260	151	140	260

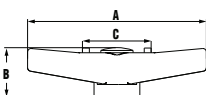

Maneta bidireccional
Compact bidirectional model handle
Poignée modèle Compact bidirectionelle

825

CÓDIGO / CODE	Ø TUBO / PIPE	PESO / WT (g.)	A	B	C
11D951	20	15	80	32	32
11D952	25	15	80	33	38
11D953	32	23	101	36	45
11D954	40	39	130	44	56
11D955	50	39	130	45	66
11D956	63	79	170	57	80
11D957	75	155	260	68	106
11D958	90	155	260	68	120

ACTUADOR ELÉCTRICO/ ELECTRIC ACTUATOR

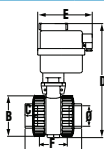

653/668

PTFE

VITON

Salida encolar
Solvent socket outlet
Sortie à collier

CÓDIGO / CODE	CÓDIGO / CODE	Ø TUBO / PIPE	MOTOR	DN	PESO / WT (g.)	A	B	C	D	E	F
11D299	11D349	20	H10	15	1.078	86	55	16	227	177	44
11D300	11D350	25	H10	20	1.119	94	62	19	232	177	49
11D301	11D351	32	H10	25	1.259	122	72	23	243	177	66
11D302	11D352	40	H20	32	2.119	131	88	25	265	177	71
11D303	11D353	50	H20	40	2.376	150	103	31	282	177	75
11D304	11D354	63	H20	50	2.840	177	120	38	390	177	89
11D305	11D355	75	H35	65	4.550	216	150	45	401	177	119
11D306	11D356	90	H55	80	6.630	257	181	51	450	177	140

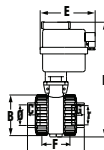

654/669

PTFE

VITON

Salida mixta encolar R/H
Solvent socket/female threaded outlet
Sortie mixte

CÓDIGO / CODE	CÓDIGO / CODE	Ø TUBO / PIPE	MOTOR	DN	PESO / WT (g.)	A	B	C	D	E	F	G
11D329	11D379	20-1/2"	H10	15	1.085	86	55	16	227	177	44	17
11D330	11D380	25-3/4"	H10	20	1.129	99	62	19	232	177	49	20
11D331	11D381	32-1"	H10	25	1.262	122	72	23	243	177	66	23
11D332	11D382	40-1 1/4"	H20	32	2.121	131	88	25	265	177	71	26
11D333	11D383	50-1 1/2"	H20	40	2.414	155	103	31	282	177	75	33
11D334	11D384	63-2"	H20	50	2.934	180	120	38	390	177	89	29
11D335	11D385	75-2 1/2"	H35	65	4.580	202	150	45	401	177	119	33
11D336	11D386	90-3"	H55	80	6.690	245	181	51	450	177	140	36

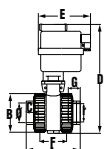

655/670

PTFE

VITON

Salida mixta encolar R/H reforz.
Reinforced solvent socket/female threaded outlet
Sortie mixte renforcée

CÓDIGO / CODE	CÓDIGO / CODE	Ø - r	MOTOR	DN	PESO / WT (g.)	A	B	C	D	E	F	G
11D339	11D389	20-1/2"	H10	15	1.109	86	55	16	227	177	44	17
11D340	11D390	25-3/4"	H10	20	1.157	99	62	19	232	177	49	20
11D341	11D391	32-1"	H10	25	1.294	122	72	23	243	177	66	23
11D342	11D392	40-1 1/4"	H20	32	2.162	131	88	25	265	177	71	26
11D343	11D393	50-1 1/2"	H20	40	2.470	155	103	31	282	177	75	33
11D344	11D394	63-2"	H20	50	3.011	180	120	38	390	177	89	29
11D345	11D395	75-2 1/2"	H35	65	4.625	202	150	45	401	177	119	33
11D346	11D396	90-3"	H55	80	6.750	245	181	51	450	177	140	36

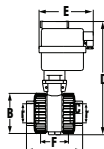

656/671

PTFE

VITON

Salida R/Hembra
Female-female threaded outlet
Sortie taraudée

CÓDIGO / CODE	CÓDIGO / CODE	r	MOTOR	DN	PESO / WT (g.)	A	B	C	D	E	F
11D309	11D359	1/2"	H10	15	1.080	86	55	17	227	177	44
11D310	11D360	3/4"	H10	20	1.124	99	62	20	232	177	49
11D311	11D361	1"	H10	25	1.261	122	72	23	243	177	66
11D312	11D362	1 1/4"	H20	32	2.120	131	88	26	265	177	71
11D313	11D363	1 1/2"	H20	40	2.398	155	103	33	282	177	75
11D314	11D364	2"	H20	50	2.952	180	120	29	390	177	89
11D315	11D365	2 1/2"	H35	65	4.610	202	150	33	401	177	119
11D316	11D366	3"	H55	80	6.760	232	181	36	450	177	140

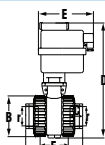

657/672



Salida R/H reforzada
Reinforced female threaded outlet
Sortie taraudée renforcée

CÓDIGO / CODE	CÓDIGO / CODE	r	MOTOR	DN	PESO / WT (g.)	A	B	C	D	E	F
11D319	11D369	1/2"	H10	15	1.092	86	55	17	227	177	44
11D320	11D370	3/4"	H10	20	1.138	99	62	20	232	177	49
11D321	11D371	1"	H10	25	1.277	122	72	23	243	177	66
11D322	11D372	1 1/4"	H20	32	2.141	131	88	26	265	177	71
11D323	11D373	1 1/2"	H20	40	2.426	155	103	33	282	177	75
11D324	11D374	2"	H20	50	2.991	180	120	29	390	177	89
11D325	11D375	2 1/2"	H35	65	4.680	202	150	33	401	177	119
11D326	11D376	3"	H55	80	6.880	232	181	36	450	177	140

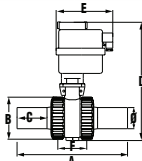

688/691



Salida termofusión
Thermofusion outlet
Sortie thermofusion

CÓDIGO / CODE	CÓDIGO / CODE	Ø TUBO / PIPE	MOTOR	DN	PESO / WT (g.)	A	B	C	D	E	F
11D400	11D410	20	H10	15	1.086	212	55	65	227	177	44
11D401	11D411	25	H10	20	1.129	221	62	65	232	177	49
11D402	11D412	32	H10	25	1.259	256	72	70	243	177	66
11D403	11D413	40	H20	32	2.119	261	88	70	265	177	71
11D404	11D414	50	H20	40	2.376	285	103	79	282	177	75
11D405	11D415	63	H20	50	2.840	327	120	89	390	177	89
11D406	11D416	75	H35	65	4.550	369	150	91	401	177	119
11D407	11D417	90	H55	80	6.630	410	181	100	450	177	140

ACTUADOR NEUMÁTICO SIMPLE EFECTO / PNEUMATIC ACTUATOR SINGLE ACTING

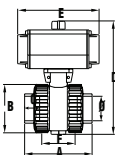

658/673



Salida encolar
Solvent socket outlet
Sortie à collier

CÓDIGO / CODE	CÓDIGO / CODE	Ø TUBO / PIPE	MOTOR	DN	PESO / WT (g.)	A	B	C	D	E	F
11D500	11D550	20	H050SE	15	1.378	86	55	16	192	138	44
11D501	11D551	25	H050SE	20	1.419	94	62	19	197	138	49
11D502	11D552	32	H050SE	25	1.559	122	72	23	208	138	66
11D503	11D553	40	H063SE	32	2.419	131	88	25	248	155	71
11D504	11D554	50	H063SE	40	2.676	150	103	31	265	155	75
11D505	11D555	63	H063SE	50	3.140	177	120	38	307	155	89
11D506	11D556	75	H075SE	65	6.020	216	150	45	376	210	119
11D507	11D557	90	H100SE	80	11.050	257	181	51	426	280	140

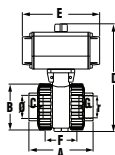

659/674



Salida mixta encolar R/H
Solvent socket/female threaded outlet
Sortie mixte

CÓDIGO / CODE	CÓDIGO / CODE	Ø - r	MOTOR	DN	PESO / WT (g.)	A	B	C	D	E	F	G
11D530	11D580	20-1/2"	H050SE	15	1.385	86	55	16	192	138	44	17
11D531	11D581	25-3/4"	H050SE	20	1.429	99	62	19	197	138	49	20
11D532	11D582	32-1"	H050SE	25	1.562	122	72	23	208	138	66	23
11D533	11D583	40-1 1/4"	H063SE	32	2.421	131	88	25	248	155	71	26
11D534	11D584	50-1 1/2"	H063SE	40	2.714	155	103	31	265	155	75	33
11D535	11D585	63-2"	H063SE	50	3.234	180	120	38	307	155	89	29
11D536	11D586	75-2 1/2"	H075SE	65	6.050	202	150	45	376	210	119	33
11D537	11D587	90-3"	H100SE	80	11.110	245	181	51	426	280	140	36

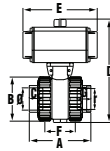

660/675

PTFE

VITON

Salida mixta encolar R/H reforz.
Reinforced solvent socket/female threaded outlet
Sortie mixte renforcée

CÓDIGO / CODE	CÓDIGO / CODE	Ø - r	MOTOR	DN	PESO / WT (g.)	A	B	C	D	E	F	G
11D540	11D590	20-1/2"	H050SE	15	1.409	86	55	16	192	138	44	17
11D541	11D591	25-3/4"	H050SE	20	1.457	99	62	19	197	138	49	20
11D542	11D592	32-1"	H050SE	25	1.594	122	72	23	208	138	66	23
11D543	11D593	40-1 1/4"	H063SE	32	2.462	131	88	25	248	155	71	26
11D544	11D594	50-1 1/2"	H063SE	40	2.770	155	103	31	265	155	75	33
11D545	11D595	63-2"	H063SE	50	3.311	180	120	38	307	155	89	29
11D546	11D596	75-2 1/2"	H075SE	65	6.095	202	150	45	376	210	119	33
11D547	11D597	90-3"	H100SE	80	11.170	245	181	51	426	280	140	36

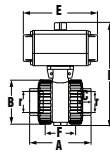

661/676

PTFE

VITON

Salida R/Hembra
Female-female threaded outlet
Sortie taraudée

CÓDIGO / CODE	CÓDIGO / CODE	r	MOTOR	DN	PESO / WT (g.)	A	B	C	D	E	F
11D510	11D560	1/2"	H050SE	15	1.380	86	55	17	192	138	44
11D511	11D561	3/4"	H050SE	20	1.424	99	62	20	197	138	49
11D512	11D562	1"	H050SE	25	1.561	122	72	23	208	138	66
11D513	11D563	1 1/4"	H063SE	32	2.420	131	88	26	248	155	71
11D514	11D564	1 1/2"	H063SE	40	2.698	155	103	33	265	155	75
11D515	11D565	2"	H063SE	50	3.252	180	120	29	307	155	89
11D516	11D566	2 1/2"	H075SE	65	6.080	202	150	33	376	210	119
11D517	11D567	3"	H100SE	80	11.180	232	181	36	426	280	140

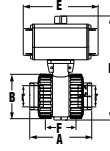

662/677

PTFE

VITON

Salida R/H reforzada
Reinforced female threaded outlet
Sortie taraudée renforcée

CÓDIGO / CODE	CÓDIGO / CODE	r	MOTOR	DN	PESO / WT (g.)	A	B	C	D	E	F
11D520	11D570	1/2"	H050SE	15	1.392	86	55	17	192	138	44
11D521	11D571	3/4"	H050SE	20	1.438	99	62	20	197	138	49
11D522	11D572	1"	H050SE	25	1.577	122	72	23	208	138	66
11D523	11D573	1 1/4"	H063SE	32	2.441	131	88	26	248	155	71
11D524	11D574	1 1/2"	H063SE	40	2.726	155	103	33	265	155	75
11D525	11D575	2"	H063SE	50	3.291	180	120	29	307	155	89
11D526	11D576	2 1/2"	H075SE	65	6.150	202	150	33	376	210	119
11D527	11D577	3"	H100SE	80	11.300	232	181	36	426	280	140

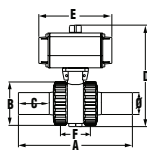
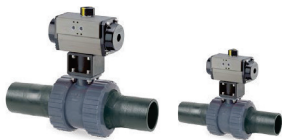

689/692

PTFE

VITON

Salida termofusión
Thermofusion outlet
Sortie thermofusion

CÓDIGO / CODE	CÓDIGO / CODE	Ø TUBO / PIPE	MOTOR	DN	PESO / WT (g.)	A	B	C	D	E	F
11D700	11D720	20	H050SE	15	1.386	212	55	65	192	138	44
11D701	11D721	25	H050SE	20	1.429	221	62	65	197	138	49
11D702	11D722	32	H050SE	25	1.559	256	72	70	208	138	66
11D703	11D723	40	H063SE	32	2.419	261	88	70	248	155	71
11D704	11D724	50	H063SE	40	2.676	285	103	79	265	155	75
11D705	11D725	63	H063SE	50	3.140	327	120	89	307	155	89
11D706	11D726	75	H075SE	65	6.020	369	150	91	376	210	119
11D707	11D727	90	H100SE	80	11.050	410	181	100	426	280	140

ACTUADOR NEUMÁTICO DOBLE EFECTO / PNEUMATIC ACTUATOR DOUBLE ACTING

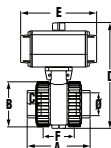

Salida encolar
Solvent socket outlet
Sortie à collier

663/678



CÓDIGO / CODE	CÓDIGO / CODE	Ø TUBO / PIPE	MOTOR	DN	PESO / WT (g.)	A	B	C	D	E	F
11D600	11D650	20	H050DE	15	1.278	86	55	16	192	138	44
11D601	11D651	25	H050DE	20	1.323	94	62	19	197	138	49
11D602	11D652	32	H050DE	25	1.474	122	72	23	209	138	66
11D603	11D653	40	H050DE	32	1.746	131	88	25	232	138	71
11D604	11D654	50	H050DE	40	2.038	150	103	31	249	138	75
11D605	11D655	63	H050DE	50	2.562	177	120	38	291	138	89
11D606	11D656	75	H075DE	65	5.550	216	150	45	375	210	119
11D607	11D657	90	H075DE	80	7.130	257	181	51	402	210	140

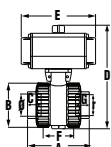

Salida mixta encolar R/H
Solvent socket/female threaded outlet
Sortie mixte

664/679



CÓDIGO / CODE	CÓDIGO / CODE	Ø - r	MOTOR	DN	PESO / WT (g.)	A	B	C	D	E	F	G
11D580	11D680	20-1/2"	H050DE	15	1.285	86	55	16	192	138	44	17
11D581	11D681	25-3/4"	H050DE	20	1.333	99	62	19	197	138	49	20
11D582	11D682	32-1"	H050DE	25	1.478	122	72	23	209	138	66	23
11D583	11D683	40-1 1/4"	H050DE	32	1.748	131	88	25	232	138	71	26
11D584	11D684	50-1 1/2"	H050DE	40	2.079	155	103	31	249	138	75	33
11D585	11D685	63-2"	H050DE	50	2.665	180	120	38	291	138	89	29
11D586	11D686	75-2 1/2"	H075DE	65	5.580	202	150	45	375	210	119	33
11D587	11D687	90-3"	H075DE	80	7.190	245	181	51	402	210	140	36

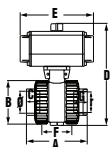

Salida mixta encolar R/H reforz.
Reinforced solvent socket/female threaded outlet
Sortie mixte renforcée

665/680



CÓDIGO / CODE	CÓDIGO / CODE	Ø - r	MOTOR	DN	PESO / WT (g.)	A	B	C	D	E	F	G
11D640	11D690	20-1/2"	H050DE	15	1.309	86	55	16	192	138	44	17
11D641	11D691	25-3/4"	H050DE	20	1.362	99	62	19	197	138	49	20
11D642	11D692	32-1"	H050DE	25	1.512	122	72	23	209	138	66	23
11D643	11D693	40-1 1/4"	H050DE	32	1.791	131	88	25	232	138	71	26
11D644	11D694	50-1 1/2"	H050DE	40	2.139	155	103	31	249	138	75	33
11D645	11D695	63-2"	H050DE	50	2.749	180	120	38	291	138	89	29
11D646	11D696	75-2 1/2"	H075DE	65	5.625	202	150	45	375	210	119	33
11D647	11D697	90-3"	H075DE	80	7.250	245	181	51	402	210	140	36

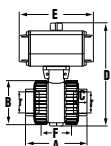

Salida R/Hembra
Female-female threaded outlet
Sortie taraudée

666/681



CÓDIGO / CODE	CÓDIGO / CODE	r	MOTOR	DN	PESO / WT (g.)	A	B	C	D	E	F
11D610	11D660	1/2"	H050DE	15	1.280	86	55	17	192	138	44
11D611	11D661	3/4"	H050DE	20	1.328	99	62	20	197	138	49
11D612	11D662	1"	H050DE	25	1.477	122	72	23	209	138	66
11D613	11D663	1 1/4"	H050DE	32	1.747	131	88	26	232	138	71
11D614	11D664	1 1/2"	H050DE	40	2.062	155	103	33	249	138	75
11D615	11D665	2"	H050DE	50	2.684	180	120	29	291	138	89
11D616	11D666	2 1/2"	H075DE	65	5.610	202	150	33	375	210	119
11D617	11D667	3"	H075DE	80	7.260	232	181	36	402	210	140

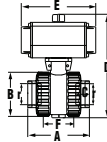

Salida R/H reforzada
Reinforced female threaded outlet
Sortie taraudée renforcée

667/682

PTFE

VITON

CÓDIGO / CODE	CÓDIGO / CODE	r	MOTOR	DN	PESO / WT (g.)	A	B	C	D	E	F
11D620	11D670	1/2"	H050DE	15	1.292	86	55	17	192	138	44
11D621	11D671	3/4"	H050DE	20	1.342	99	62	20	197	138	49
11D622	11D672	1"	H050DE	25	1.494	122	72	23	209	138	66
11D623	11D673	1 1/4"	H050DE	32	1.768	131	88	26	232	138	71
11D624	11D674	1 1/2"	H050DE	40	2.092	155	103	33	249	138	75
11D625	11D675	2"	H050DE	50	2.726	180	120	29	291	138	89
11D626	11D676	2 1/2"	H075DE	65	5.680	202	150	33	375	210	119
11D627	11D677	3"	H075DE	80	7.380	232	181	36	402	210	140

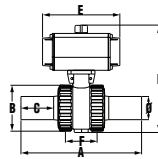

Salida termofusión
Thermofusion outlet
Sortie thermofusion

690/693

PTFE

VITON

CÓDIGO / CODE	CÓDIGO / CODE	Ø TUBO / PIPE	MOTOR	DN	PESO / WT (g.)	A	B	C	D	E	F
11D710	11D730	20	H050DE	15	1.286	212	55	65	192	138	44
11D711	11D731	25	H050DE	20	1.333	221	62	65	197	138	49
11D712	11D732	32	H050DE	25	1.474	256	72	70	209	138	66
11D713	11D733	40	H050DE	32	1.746	261	88	70	232	138	71
11D714	11D734	50	H050DE	40	2.038	285	103	79	249	138	75
11D715	11D735	63	H050DE	50	2.562	327	120	89	291	138	89
11D716	11D736	75	H075DE	65	5.550	369	150	91	375	210	119
11D717	11D737	90	H075DE	80	7.130	410	181	100	402	210	140